

## Scope of Supply/Bill of Material & Mounting Drawings

**Part Number: H-CRF300L-04-01-AL / H-CRF300L-04-02-AL / H-CRF300L-04-03-AL**

**Part Description Top Rack–HONDA CRF 300 L / HONDA CRF 300 RALLY**

**Applicable to Finished colour versions of Black**

### Installation / Parts List / Bill of Material for Mounting

NO.	Description	Quantity	Torque * (N-M)	Remarks **
1	Top Rack	1		
2	Rack LH	1		
3	Rack RH	1		
4	Bush 18 x 31	2		
5	Bush 18 x 38	2		
6	Cap lock	1		
7	Flank	1		
8	Nut plate	2		
9	Oil Tank 3 Liter	1		
10	Plastic Knobs	1		
11	Countersunk Washer M8	4		
12	Socket head cap Screw M5 x 15	8	5.5	Use Liquid Thread Locker
13	Socket countersunk head cap Screw M5 x 15	4	5.5	Use Liquid Thread Locker
14	Socket countersunk head cap Screw M8 x 60	2	23	Use Liquid Thread Locker
15	Socket countersunk head cap Screw M8 x 65	2	23	Use Liquid Thread Locker
16	Washer M5	8		

SRC Design uses Metric System of Measurement and all dimensions in Millimeters

\* Recommended to use the Torque specified in the table

\*\* Denotes Usage of Liquid Thread Locker in specified Locations

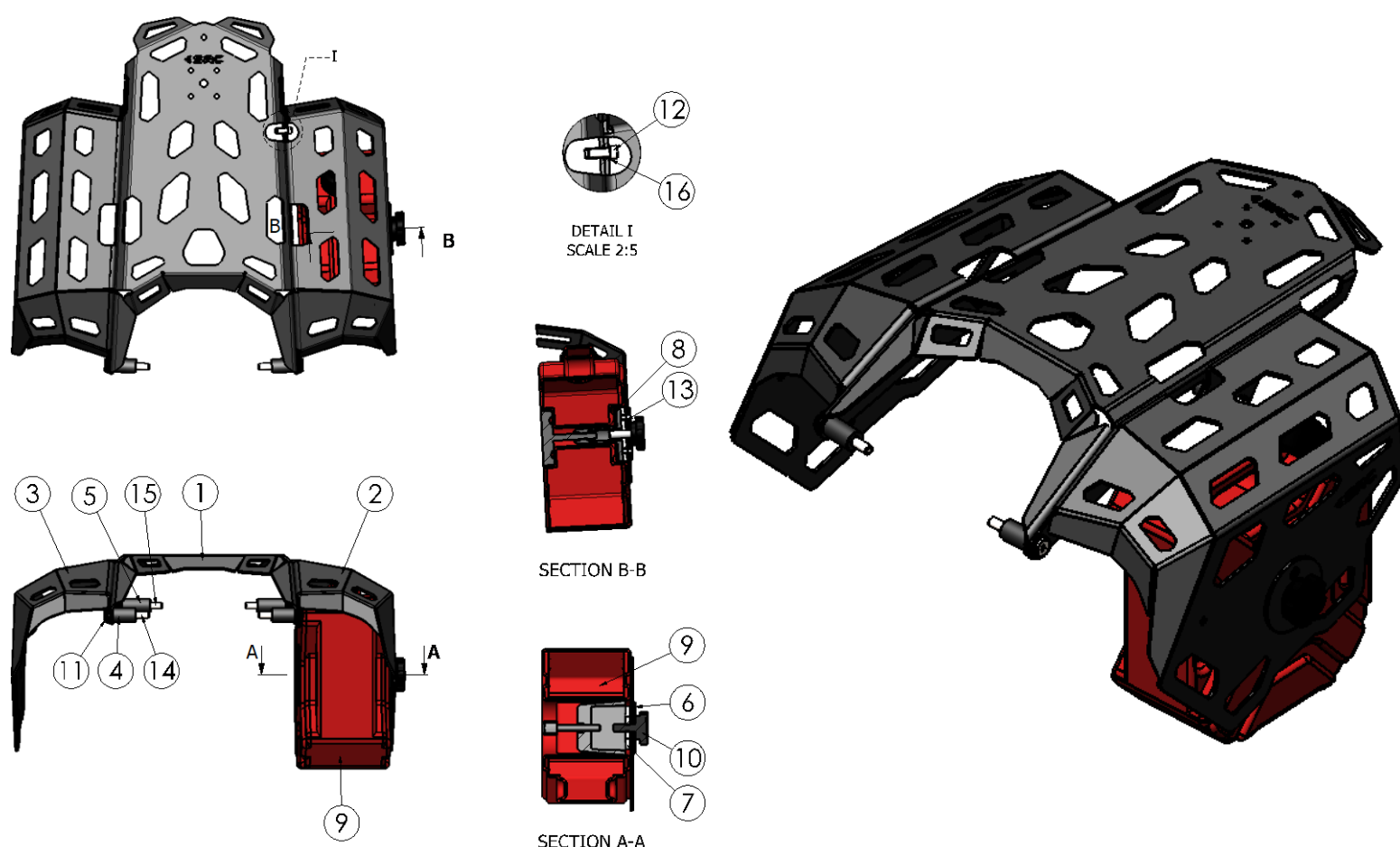

Copyright By SRC

Design and Specification are subjected to change

**Mounting Instruction**

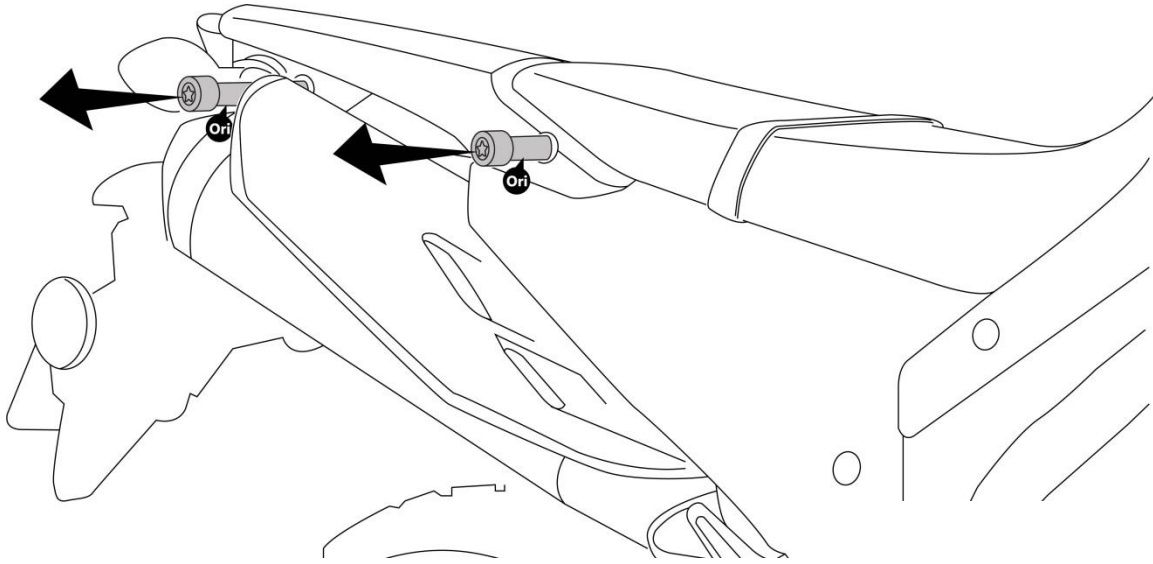

**Step 1:**  
**Before starting to mount the Top Rack we can remove the original screw in motorbike (as show)**

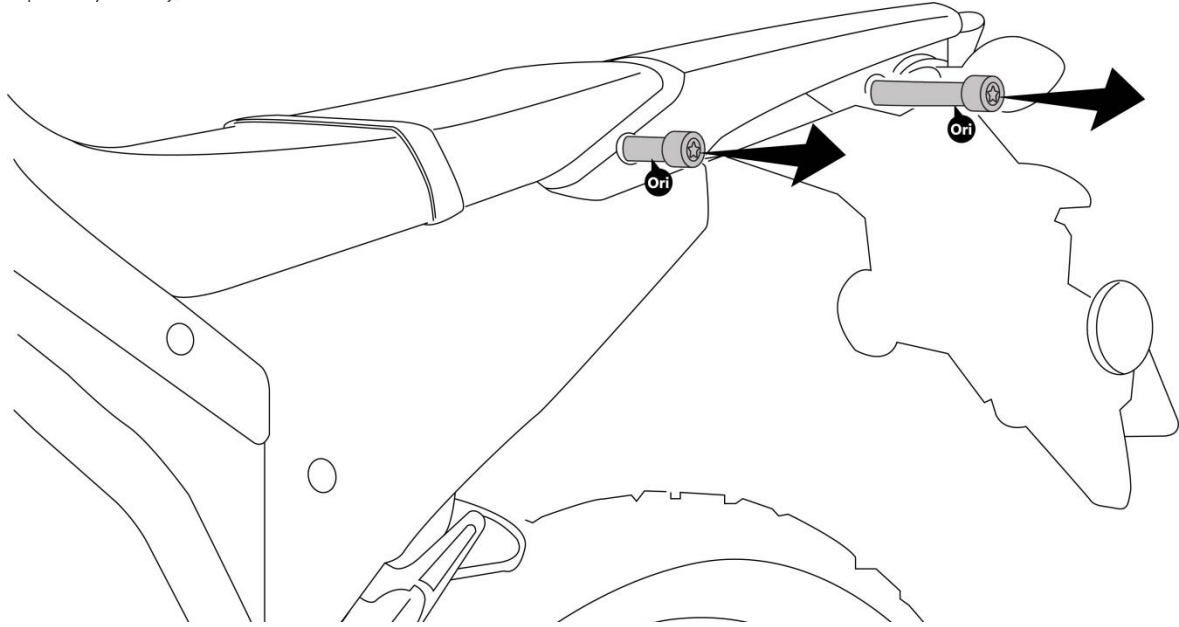

**Step 2:**  
**Repeat the Step 1 for mounting the Top Rack, as shown**

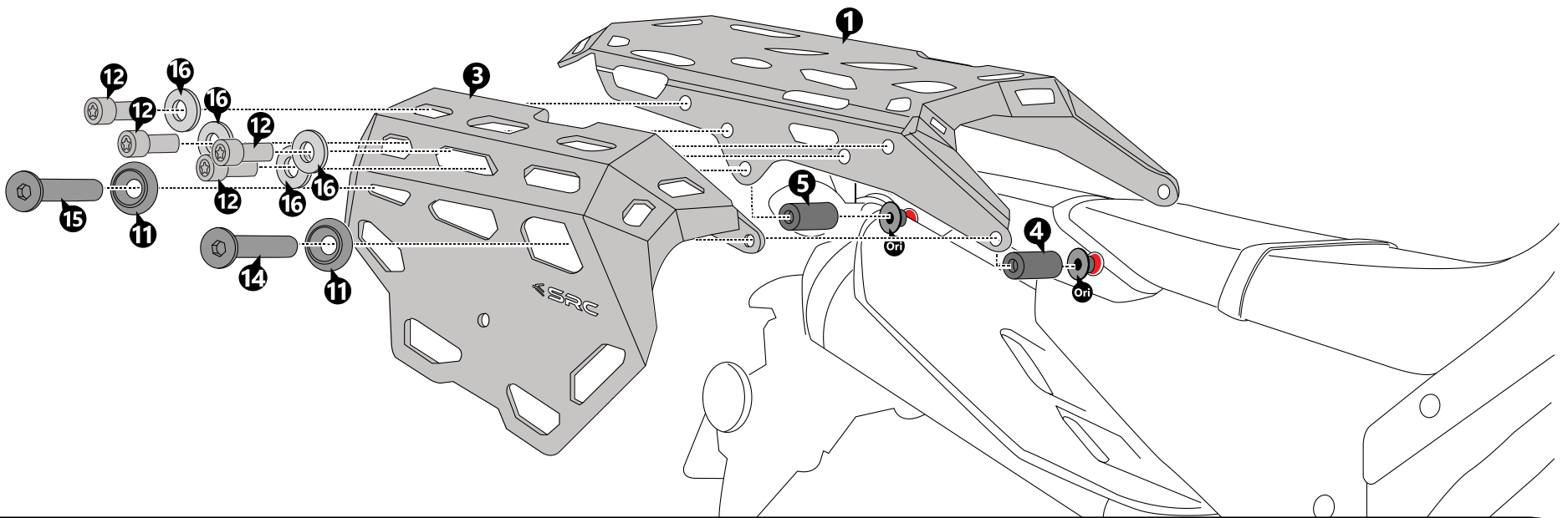

**Step 3:**  
**Orient and Align the Top Rack (1), as shown, Slip-in the Bush Spacer 18 x 31 mm (4) – 1 off between the Mounting hole front side and Slip-in Screw M8 x 60 (14) – 1 off and Taper Ring M8 (11) – 1 off , Slip-in the Bush Spacer 18 x 38 mm (5) – 1 off between the Mounting End hole and Slip-in Screw M8 x 65 (15) – 1 off and Taper Ring M8 (11) – 1 off, and slip-in the screw M5 x 15 (13) - 4 off , washer M5 (16) - 4 off ,through the holes and secure the threads.**

**Step 4:**

**Repeat the above step  
for the other side to  
secure the threads.**

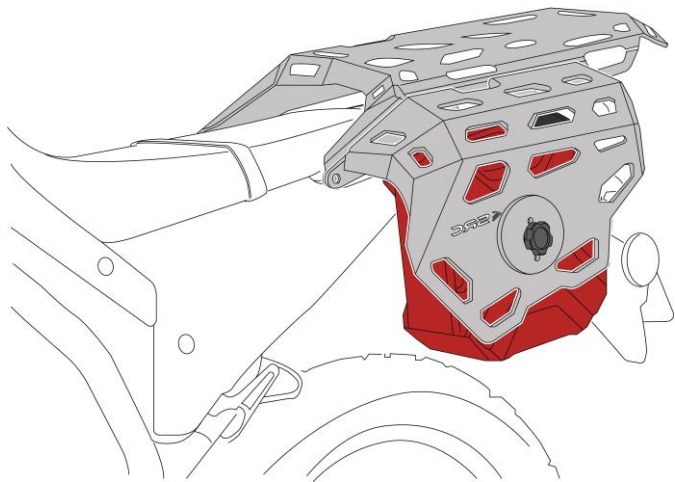
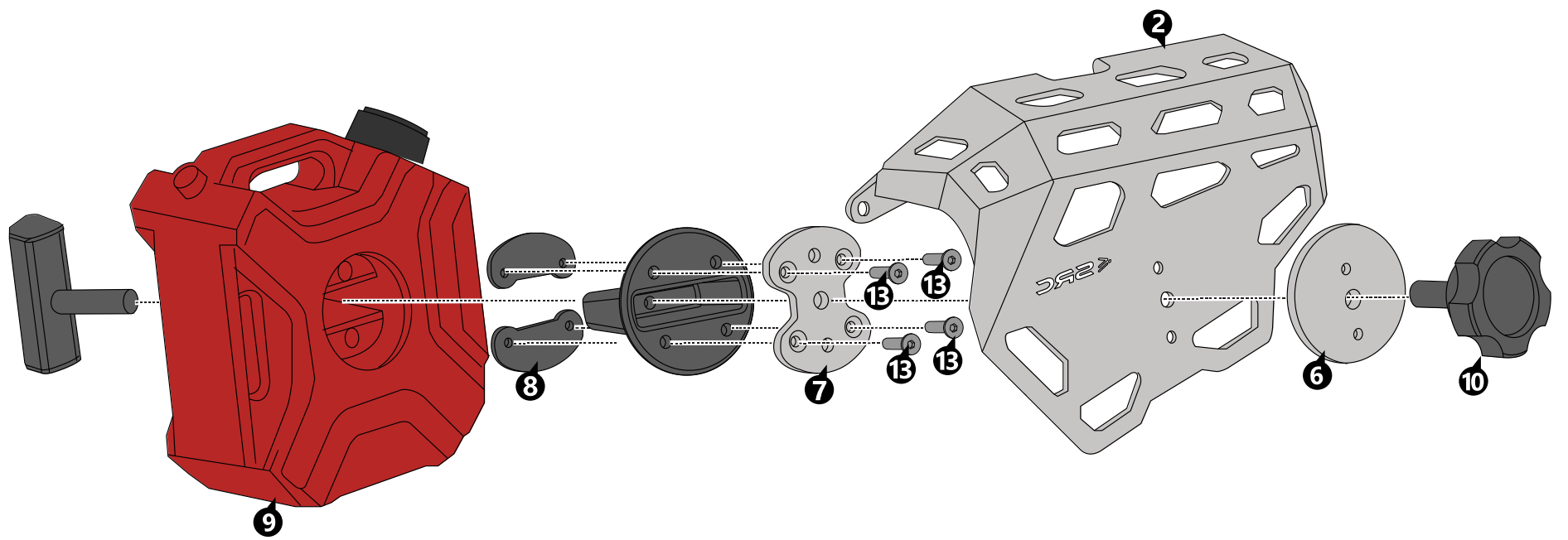
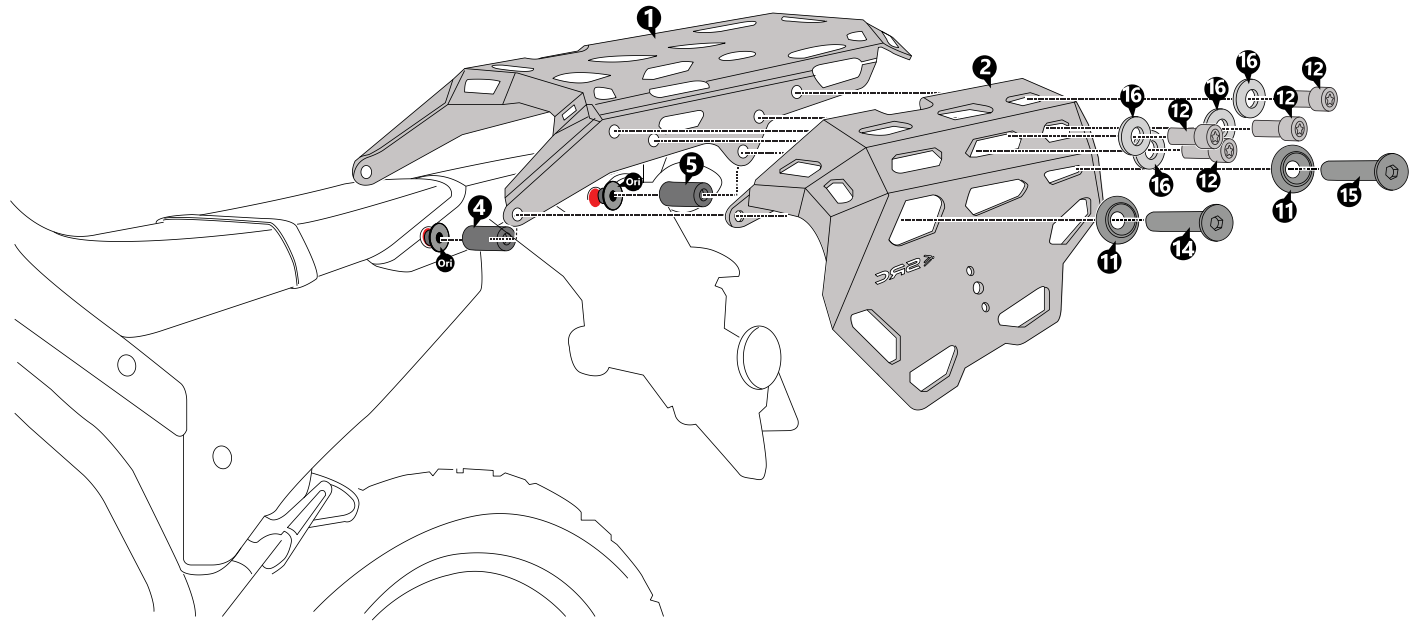

**Step 5:**

**Mounting Set Oil !**



## General Instructions

1. We request you to pay attention to the Mounting Instructions in this document and follow the step-by-step procedures.
2. This Mounting Instruction manual is a “Do It Yourself” (DIY) fitment manual of the Accessory part to the Vehicle. We have prepared this based on our experience and knowledge, related to the Vehicle, Part and its functional aspects.
3. SRC cannot guarantee the interchangeability of the parts to any other manufacturer’s accessory part. It is advised to the User, to inspect and ensure the original state of all other Vehicle parts.
4. We request you to bear in mind, that the Installed part can change the driving behaviour and/or the stability during driving or any other dynamic conditions.
5. If you have the appropriate tools and another person to assist you in the mounting, it will help.
6. After Completion of the Mounting and before taking on a First ride, Ensure and Check all functions of the Vehicle. It is always advised to check loosening of the fasteners after the first 50 kilo meters of ride and at regular intervals.
7. We are showing here the Scope of Supply/ Installation/Parts list & BOM from SRC
8. To the maximum extent possible, our design use the current Mounting/Fitment of the Original Equipment, so that Installation of these accessories will not affect the Payload or Function of the Vehicle or the Part on which it is mounted to protect it
9. If any additional modifications are to be done, prior to the fitment of the accessories, it will be explicitly specified in the instruction sheets